



Vegetable Slicer
TRS Vegetable slicer, 1 speed,
640w, nema 5-15p

ITEM # _____
 MODEL # _____
 NAME # _____
 SIS # _____
 AIA # _____



602256 (DTR24SNU)

TRS Classic Vegetable Slicer, single speed, 640W/1Hp. (No discs included).

Short Form Specification

Item No. _____

TRS Classic Vegetable Slicer, single speed, 640W/1Hp. (No discs included). Universal vegetable preparation machine for more than 80 different types of cuts. Stainless steel motor casing. Removable cover and feed arm in polished cast aluminium with incorporated magnetic safety device which only allows the cutter to operate if the hopper is closed. No volt release system. Self braking motor.

Main Features

- Suitable for 100-300 meals for table service and up to 600 meals for catering service.
- Vegetable slicer unit has slicing, grating, shredding (julienne) as well as dicing and french fries capabilities.
- Delivered with: polished cast aluminium vegetable preparation attachment with a lever-integrated long vegetable hopper 2" diameter (52mm) and a large half moon hopper 6"x3" (154x77mm).
- Ergonomically design to work frontally and to reduce the working space around the machine.
- Hopper easily removed for cleaning.
- Base inclined at 20° to provide easy loading and unloading.
- Complete and wide selection of blades and grids available, Diameter of blades and grids are 8" (205mm).
- Magnetic safety system and motor brake. Prevents machine from running when lever swings away or is open.
- Automatic restart of the machine with the half-moon shaped lever in position.
- Continuous feed model.

Construction

- Asynchronous industrial motor with no brushes for high reliability and quiet functioning, stainless steel motor shaft.
- 1 speed: 400 rpm - for precise cutting, slicing and dicing.
- Power: 750 watts (1 HP).
- IP55 waterproof ON/OFF buttons, IP24 throughout the entire machine.
- Compact and portable design.

Optional Accessories

- Stainless steel shredding disc with PNC 650077
 S-blades 5/32" x 5/32" (4x4 mm)
- Stainless steel shredding disc with PNC 650078
 S-blades 1/4"x 1/4" (6x6 mm) (can also be used for French fries)
- Stainless steel shredding disc with PNC 650079
 S-blades 5/16" x 5/16" (8x8 mm) (can also be used for French fries)
- Stainless steel shredding disc with PNC 650080
 S-blades 3/8" x 3/8" (10x10 mm) (can also be used for French fries)
- Stainless steel pressing/slicing disc PNC 650081
 with S-blades .6 mm (can be used for slicing or combined with grids)
- Stainless steel pressing/slicing disc PNC 650082
 with S-blades 1/32" (1 mm) (can be used for slicing or combined with grids)

APPROVAL: _____

TRS Vegetable slicer, 1 speed, 640w, nema 5-15p
Vegetable Slicer



Vegetable Slicer

TRS Vegetable slicer, 1 speed, 640w, nema 5-15p

• Stainless steel pressing/slicing disc with S-blades 5/64" (2 mm) (can be used for slicing or combined with grids)	PNC 650083	<input type="checkbox"/>	• Aluminum pressing/slicing disc with straight blades 10 mm - for dicing	PNC 650115	<input type="checkbox"/>
• Stainless steel pressing/slicing disc with S-blades 1/8" (3 mm) (can be used for slicing or combined with grids)	PNC 650084	<input type="checkbox"/>	• Aluminum pressing/slicing disc with straight blades 8 mm - for dicing	PNC 650116	<input type="checkbox"/>
• Stainless steel pressing/slicing disc with S-blades 5/32" (4 mm) (can be used for slicing or combined with grids)	PNC 650085	<input type="checkbox"/>	• Stainless steel shredding disc with S-blades 5/64" x 5/16" (2x8 mm)	PNC 650158	<input type="checkbox"/>
• Stainless steel pressing/slicing disc with S-blades 3/16" (5 mm) (can be used for slicing or combined with grids)	PNC 650086	<input type="checkbox"/>	• Stainless steel shredding disc with S-blades 5/64" x 3/8" (2x10 mm)	PNC 650159	<input type="checkbox"/>
• Stainless steel pressing/slicing disc with S-blades 1/4" (6 mm) (can be used for slicing or combined with grids)	PNC 650087	<input type="checkbox"/>	• Stainless steel pressing/slicing disc with S-blades 3/8" (10 mm) (can be used for slicing or combined with grids)	PNC 650160	<input type="checkbox"/>
• Stainless steel pressing/slicing disc with S-blades 5/16" (8 mm) (can be used for slicing or combined with grids)	PNC 650088	<input type="checkbox"/>	• Stainless steel pressing/slicing disc with S-blades 15/32" (12 mm) (can be used for slicing or combined with grids)	PNC 650161	<input type="checkbox"/>
• Stainless steel pressing/slicing disc with corrugated S-blades 5/64" (2 mm) (can be used for slicing or combined with grids)	PNC 650089	<input type="checkbox"/>	• Stainless steel pressing/slicing disc with corrugated S-blades 5/16" (8 mm) (can be used for slicing or combined with grids)	PNC 650162	<input type="checkbox"/>
• Stainless steel pressing/slicing disc with corrugated S-blades 1/8" (3 mm) (can be used for slicing or combined with grids)	PNC 650090	<input type="checkbox"/>	• Stainless steel pressing/slicing disc with corrugated S-blades 3/8" (10 mm) (can be used for slicing or combined with grids)	PNC 650164	<input type="checkbox"/>
• Stainless steel pressing/slicing disc with corrugated S-blades 1/4" (6 mm) (can be used for slicing or combined with grids)	PNC 650091	<input type="checkbox"/>	• Stainless steel pressing/slicing disc with S-blades 33/64" (13 mm) (can be used for slicing or combined with grids)	PNC 650165	<input type="checkbox"/>
• Bistrot Pack, Stainless Steel Disc Set containing one each of: C2SX 5/64" (2mm) slicing disc, C5SX 3/16" (5mm) slicing disc, J2X 5/64" (2mm) grating disc	PNC 650092	<input type="checkbox"/>	• Stainless steel shredding disc with S-blades 5/64"x 5/64" (2x2 mm)	PNC 650166	<input type="checkbox"/>
• Set of 3 stainless steel discs for Pizza 5/64", 5/32", 9/32" (2mm and 4mm pressing/slicing discs with S-blades, 7mm grating disc)	PNC 650107	<input type="checkbox"/>	• Stainless steel shredding disc with S-blades 1x8" x 1/8" (3x3 mm)	PNC 650167	<input type="checkbox"/>
• Cleaning tool for TRS, TRK & TR210 3/16-5/16-3/8 in (5-8-10 mm) dicing grids	PNC 650110	<input type="checkbox"/>	• Set of 4 Stainless Steel Discs containing one each of: C2S 5/64" (2mm) slicing disc, C5S 3/16" (5mm) slicing disc, J2X 5/64" (2mm) grating disc and J7X 9/32" (7mm) grating disc	PNC 650178	<input type="checkbox"/>
• Dicing set 10X10X10MM (10mm aluminum slicing pressing disc with 205mm diam. and 10mm grid)	PNC 650112	<input type="checkbox"/>	• Stainless steel work table assembly.	PNC 653283	<input type="checkbox"/>
• Gastronomy Pack-set discs (2mm, 5mm and 10mm slicing pressing discs, 2mm grating disc, 4x4mm shredding disc, 10x10mm dicing grid) and grid cleaning tool	PNC 650113	<input type="checkbox"/>	• Dicing grid 3/16" x 3/16" (5x5 mm)	PNC 653566	<input type="checkbox"/>
• Set of 7 discs (2mm, 5mm and 10mm slicing pressing discs, 2mm and 7mm grating discs, 4x4mm shredding disc, 10x10mm dicing grid) and grid cleaning tool	PNC 650114	<input type="checkbox"/>	• Dicing grid 5/16" x 5/16" (8x8 mm)	PNC 653567	<input type="checkbox"/>
			• Dicing grid 3/8"x 3/18" (10x10 mm)	PNC 653568	<input type="checkbox"/>
			• Dicing grid 15/32"x 15/32" (12x12 mm)	PNC 653569	<input type="checkbox"/>
			• Dicing grid 25/32"x 25/32" (20x20 mm)	PNC 653570	<input type="checkbox"/>
			• Grid for chips 1/4" x 1/4" (6x6 mm)	PNC 653571	<input type="checkbox"/>
			• Grid for chips 5/16"x 5/16" (8x8 mm)	PNC 653572	<input type="checkbox"/>
			• Grid for chips 3/8" x 3/8" (10x10 mm)	PNC 653573	<input type="checkbox"/>
			• Support for 1 disc, diam. 175mm and 205mm	PNC 653632	<input type="checkbox"/>
			• Stainless steel grating disc 5/64", fine (2mm)	PNC 653773	<input type="checkbox"/>
			• Stainless steel grating disc, 1/8", fine (3mm)	PNC 653774	<input type="checkbox"/>
			• Stainless steel grating disc 5/32" (4mm)	PNC 653775	<input type="checkbox"/>
			• Stainless steel grating disc 9/32" (7mm)	PNC 653776	<input type="checkbox"/>
			• Stainless steel grating disc 11/32" (9mm)	PNC 653777	<input type="checkbox"/>
			• Stainless steel grating disc, designed for nuts, chocolate & bread crumbs, stainless steel	PNC 653778	<input type="checkbox"/>
			• Stainless steel grating disc, especially fine grating for Parmesan cheese and chocolate, stainless steel	PNC 653779	<input type="checkbox"/>





Vegetable Slicer TRS Vegetable slicer, 1 speed, 640w, nema 5-15p

- Set of 3 discs, diam. 205 mm (5mm slicer, 4mm grater, 6mm julienne/shredder) PNC 653869
- Set of 5 discs, diam. 205 mm (4mm and 6mm slicer, 6mm julienne/shredder, 5mm and 10 mm slicer, 10x10mm grid) PNC 653870





Vegetable Slicer

TRS Vegetable slicer, 1 speed, 640w, nema 5-15p

Front

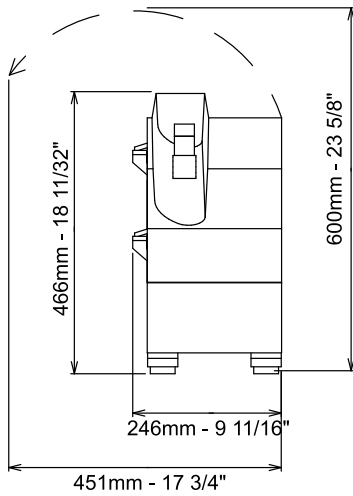

Side

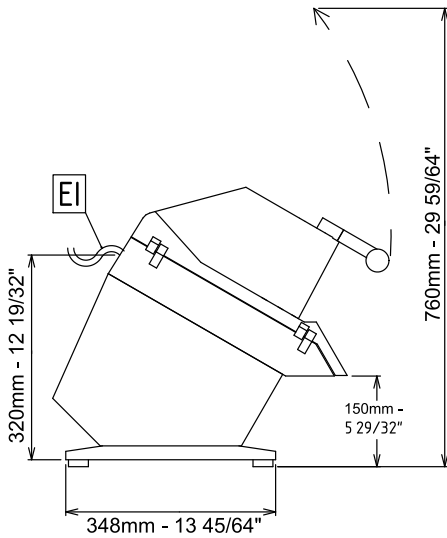

EI = Electrical connection

Top

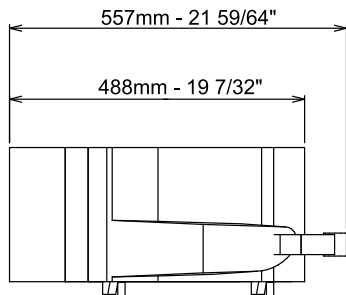

Electric

Supply voltage:

602256 (DTR24SNU) 115 V/1N ph/60 Hz

Electrical power, max: 0.64 kW

Total Watts: 0.64 kW

Capacity:

Performance (up to): 450 kg/hour

Performance (up to) 992 lbs/cycle

Key Information:

External dimensions, Width:

9 11/16" (246 mm)

External dimensions, Depth:

21 15/16" (557 mm)

External dimensions, Height:

18 3/8" (466 mm)

Shipping weight:

60 lbs (27 kg)



Vegetable Slicer
TRS Vegetable slicer, 1 speed, 640w, nema 5-15p

The company reserves the right to make modifications to the products without prior notice. All information correct at time of printing.

2024.12.21